

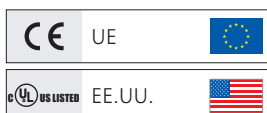

JMK Relés miniatura

1. Características

- 1.1 Capacidad de los contactos: 10A
- 1.2 Con indicador opcional
- 1.3 Amplia gama de bobinas de CA y CC
- 1.4 Certificados: CE, UL



2. Designación de modelo

JMK 2P- I / 006 / VDC

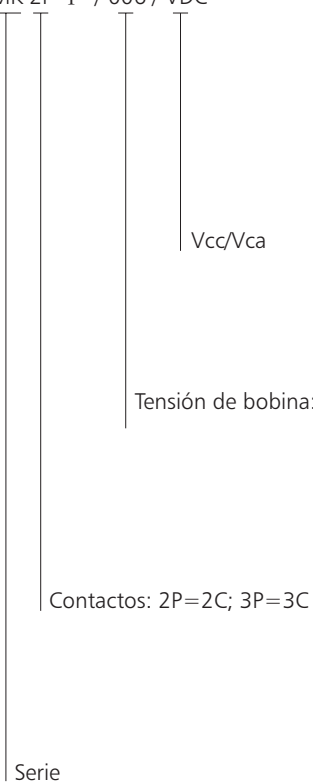

3. Características de los contactos

Contactos		2C, 3C
Resistencia de contacto inicial	mΩ	100
Material del contacto		Aleación de plata
Carga nominal (resistiva)		10A/250Vcc, 28Vcc
Tensión máxima	Vca	250
	Vcc	125
Corriente máxima	A	10
Capacidad máxima	VA	2500
	W	280
Resistencia eléctrica	Maniobras(× 10 ³)	100
Resistencia mecánica	Maniobras(× 10 ⁶)	10

4. Especificaciones de bobina

CA				
Tensión nominal	Tensión de mantenimiento	Tensión de retención mínima	Tensión de trabajo(V)	Consumo
6	80%Un	30%Un	(80%-110%) Un	3.5VA
12				
24				
48				
110				
220				
380				

CC				
Tensión nominal	Tensión de mantenimiento	Tensión de retención mínima	Tensión de trabajo(V)	Consumo
6	75%Un	10%Un	(75%-110%) Un	2W
12				
24				
36				
48				
110				
220				

5. Características técnicas

Resistencia de aislamiento (a 500Vcc)	mΩ	100
Rigidez dieléctrica	Entre bobina y contactos	1500Vca
	Entre contactos abiertos	1000Vca
Tiempo de funcionamiento	ms	≤20
Tiempo de desconexión	ms	≤20
Resistencia de choque	m/s ²	100
Vibración		10~55Hz, 1mm amplitud doble
Humedad relativa		98% HR a +20°C
Temperatura ambiente	°C	-40~+55
Tipo		Enchufable
Dimensiones	mm	35×35×52

6. Dimensiones (mm)

Esquemas de conexiones internas (vista inferior)

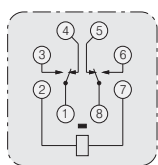

JMK2P- I

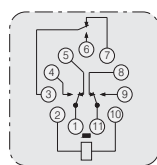

JMK3P- I

Dimensiones

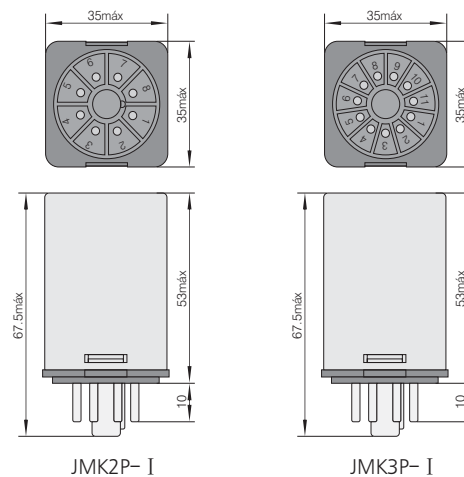

7. Enchufable

Bases de conexiones para MK2P- I

52×41×21.5(mm)

CZF08A

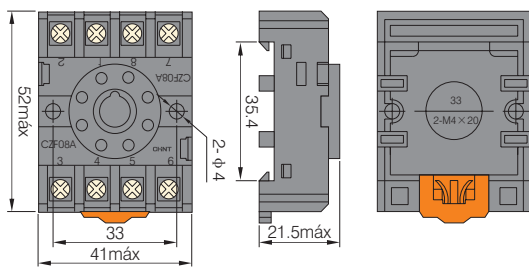

52×41×21.5(mm)

CZF08A-E
Con protección contra
contactos directos

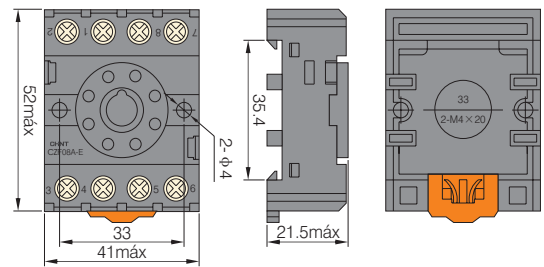

Bases de conexiones para MK3P- I

52×44×31(mm)

CZF11A

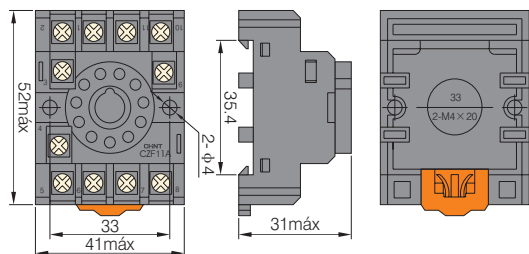

52×44×31(mm)

CZF11A-E
Con protección contra
contactos directos

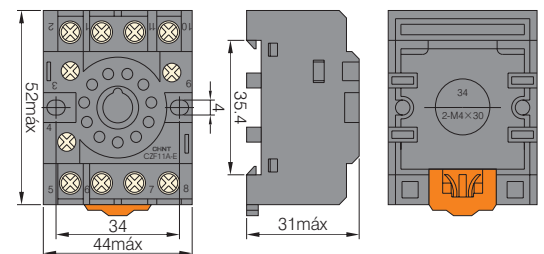

CHINT

ZHEJIANG CHINT ELECTRICS CO.,LTD

Add: No. 1, CHINT Road, CHINT Industrial Zone, North Baixiang,
Yueqing, Zhejiang Province, P.R.China 325603
Tel: +86-577-62877777
Fax: +86-577-62775769 62871811
E-mail: global-sales@chint.com
Website: www.chint.com



Febrero 2010

